

# Owner's Manual with Installation Instructions

## **Banks Six-Gun® Diesel Tuner**

**Compatible with Optional Banks iQ™**

**2007- 2010 Chevy/GMC 6.6L (LMM) Duramax  
Turbo-Diesel Pickups**

THIS MANUAL IS FOR USE WITH KITS 63887 & 63899

Gale Banks Engineering  
546 Duggan Avenue • Azusa, CA 91702  
(626) 969-9600 • Fax (626) 334-1743

Product Information & Sales: (888) 635-4565  
Customer Support: (888) 839-5600  
Installation Support: (888) 839-2700

**bankspower.com**



**THIS IS A HIGH PERFORMANCE PRODUCT. USE AT YOUR OWN RISK.**

**Do not use this product until you have carefully read the following agreement.**

**This sets forth the terms and conditions for the use of this product. The installation of this product indicates that the BUYER has read and understands this agreement and accepts its terms and conditions.**

## **Disclaimer of Liability**

Gale Banks Engineering Inc., and its distributors, employees, and dealers (hereafter "**SELLER**") shall in no way be responsible for the product's proper use and service. The **BUYER** hereby waives all liability claims.

The **BUYER** acknowledges that he/she is not relying on the **SELLER's** skill or judgment to select or furnish goods suitable for any particular purpose and that there are no liabilities which extended beyond the description on the face hereof and the **BUYER** hereby waives all remedies or liabilities, expressed or implied, arising by law or otherwise, (including without any obligations of the **SELLER** with respect to fitness, merchantability, and consequential damages) whether or not occasioned by the **SELLER's** negligence.

The **BUYER** is responsible to fully understand the capability and limitations of his/her vehicle according to manufacturer specifications and agrees to hold the **SELLER** harmless from any damage resulting from the failure to adhere to such specifications.

The **SELLER** disclaims any warranty and expressly disclaims any liability for personal injury or damages. The **BUYER** acknowledges and agrees that the disclaimer of any liability for personal injury is a material term for this agreement and the **BUYER** agrees to indemnify the **SELLER** and to hold the **SELLER** harmless from any claim related to the item of the equipment purchased. Under no circumstances will the **SELLER** be liable for any damages or expenses by reason of the use or sale of any such equipment.

The **BUYER** is responsible to obey all applicable federal, state, and local laws, statutes, and ordinances when operating his/her vehicle, and the **BUYER** agrees to hold **SELLER** harmless from any violation thereof.

The **SELLER** assumes no liability regarding the improper installation or misapplication of its products. It is the installer's responsibility to check for proper installation and if in doubt, contact the manufacturer.

The **BUYER** is solely responsible for all warranty issues from the automotive manufacturer.

## **Limitation of Warranty**

Gale Banks Engineering Inc. (hereafter "**SELLER**"), gives Limited Warranty as to description, quality, merchantability, fitness for any particular purpose, productiveness, or any other matter of **SELLER's** product sold herewith. The **SELLER** shall be in no way responsible for the product's open use and service and the **BUYER** hereby waives all rights except those expressly written herein. This Warranty shall not be extended or varied except by written instrument signed by **SELLER** and **BUYER**.

Please see enclosed warranty information card, or go to [www.bankspower.com/warranty](http://www.bankspower.com/warranty), for warranty information regarding your product. All products that are in question of Warranty must be returned shipping prepaid to the SELLER and must be accompanied by a dated proof of purchase receipt. All Warranty claims are subject to approval by Gale Banks Engineering Inc.

**WARNING:** Below 32°F (0°C) or above 140°F (60°C), the Banks iQ may be susceptible to damage as a result of extended direct exposure to sunlight, heat or extreme cold. It is highly recommended that Banks iQ be removed from its mounting location if the vehicle will be subjected to high concentrations of sunlight, heat or cold for an extended period of time. Gale Banks Engineering is not responsible for damage to Banks iQ resulting from exposure conditions.

Under no circumstance shall the **SELLER** be liable for any labor charged or travel time incurred in diagnosis for defects, removal, or reinstallation of this product, or any other contingent expense.

Under no circumstances will the **SELLER** be liable for any damage or expenses incurred by reason of the use or sale of any such equipment.

**In the event that the buyer does not agree with this agreement:**

**The buyer may promptly return this product, in a new and unused condition, with a dated proof-of-purchase, to the place-of-purchase within thirty (30) days from date-of-purchase for a full refund, less shipping and/or restocking fee.**

**The installation of this product indicates that the buyer has read and understands this agreement and accepts its terms and conditions.**

## Table of Contents

<b>Introduction</b> .....	<b>4</b>
<b>General Installation Practices</b> ....	<b>5</b>
<b>Section 1</b> .....	<b>7</b>
Installation of Wiring Harness, Connections and Six-Gun Diesel Tuner	
<b>Section 2</b> .....	<b>10</b>
Mounting and Connecting the Banks iQ	
<b>Section 3</b> .....	<b>14</b>
Installation of the (optional) Six-Gun Selector Switch	
<b>Section 4</b> .....	<b>19</b>
Optional Thermocouple Installation (Required for optional Banks iQ)	
<b>Section 5</b> .....	<b>20</b>
Automatic Transmission Learning	
<b>Section 6</b> .....	<b>21</b>
Checking Engine Performance	
<b>Section 7</b> .....	<b>22</b>
Troubleshooting	
<b>Section 8</b> .....	<b>26</b>
Clearing Learned Information	
<b>Section 9</b> .....	<b>26</b>
Removal of the Six-Gun Diesel Tuner	
<b>Section 10</b> .....	<b>27</b>
Placement of the Banks Power Decals	

# Introduction

**Dear Customer,**

**If you have any questions concerning the installation of your Banks Six-Gun Diesel Tuner, please call our Technical Service Hotline at (888) 839-2700 between 7:00am and 5:00pm (PST). If you have any questions relating to shipping or billing, please contact our Customer Service Department at (888) 839-5600.**

**Thank you.**

The Banks Six-Gun Diesel Tuner has six power levels that you can adjust with either the Six-Gun switch (supplied) or the optional Banks iQ Dashboard PC (sold separately).

Banks iQ is a versatile device that gives you total control of your Banks Six-Gun Tuner. With a touch of your finger on the bright, full-color LCD display, you can adjust power parameters, set system warnings and alerts, see vital engine functions at a glance, and more. Evaluate your changes by running 0-60,  $\frac{1}{4}$ , and  $\frac{1}{8}$  mile performance tests. You can even scan, read and clear OBD II diagnostic trouble codes.

Banks iQ doesn't stop there. It's a true in-car PC packed full of extra functions. Listen to your favorite tunes, watch videos, play games, review Windows® Office documents, and more.

Expandable and upgradeable, it comes fitted with a rechargeable battery and includes accessory cords. You'll quickly discover Banks iQ is the device you'll use every day, both inside and outside your car.

The Six-Gun Diesel Tuner comes with a Six-Gun Switch that has six selectable power levels. The Six-Gun Switch is included in the Six-Gun Diesel Tuner. Level 1 is stock. Each additional higher level adds approximately 20% of the available power increase.

To prevent damage to the factory transmission, Banks recommends that automatic transmission vehicles do not exceed Level 4 with Banks iQ while the vehicle is experiencing load (towing, climbing a steep grade, carrying a load, etc.).

To use the higher levels of the Six-Gun Diesel Tuner while towing or climbing, airflow improvements must be made to lower the exhaust gas temperature (EGT) entering the turbo. The EGT should not exceed 1400° F for more than a few seconds. Elevated EGT can damage the turbocharger and the engine.

**ATTENTION! Before proceeding with these instructions, please carefully read the DISCLAIMER OF LIABILITY and LIMITATION OF WARRANTY statement located on page 2 of this manual.**

# General Installation Practices

## TOOLS REQUIRED:

- Inch and metric sockets
- Inch and metric combination and open-end wrenches
- Pliers
- Wire cutters or scissors
- Center punch
- Drill or 90° drill
- 1/8" drill bit
- 3/8" Uni-bit step drill bit or 3/8" drill bit
- R drill bit (0.339")  
(A 5/16" drill bit (0.313") may be used if an R drill bit cannot be found)
- 1/8" NPT (National Pipe Thread) tap
- Torque wrench
- Penetrating oil or light lubricant spray
- Anti-seize compound

**1.** Before starting work, familiarize yourself with the installation procedure by reading all of the instructions.

**2.** The exploded views provide only general guidance. Refer to each step and section diagram in this manual for proper instruction.

**3.** Throughout this manual, the left side of the vehicle refers to the driver side, and the right side to the passenger side.

**4.** Disconnect the negative (ground) cable from the battery (or batteries, if there are two) before beginning work.

**5.** Route and tie wires and hoses a minimum of 6" away from exhaust heat, moving parts and sharp edges. Clearance of 8" or more is recommended where possible.

**6.** When raising the vehicle, support it on properly weight-rated safety stands, ramps or a commercial hoist.

Follow the manufacturer's safety precautions. Take care to balance the vehicle to prevent it from slipping or falling. When using ramps, be sure the front wheels are centered squarely on the topsides. When raising the front of the vehicle, put the transmission in park (automatic) or reverse (manual), set the parking brake, and block the rear wheels. When raising the back of the vehicle, be sure the vehicle is on level ground and the front wheels are blocked securely.

**CAUTION: Do not use floor jacks to support the vehicle while working under it. Do not raise the vehicle onto concrete blocks, masonry or any other item not intended specifically for this use.**

**7.** During installation, keep the work area clean. Do not allow anything to be dropped into intake, exhaust, or lubrication system components while performing the installation, as foreign objects will cause immediate engine damage upon start-up.

**8.** Save this Owner's Manual as a reference for system maintenance and service.

**9.** Banks recommends either a Banks iQ or a Pyrometer (EGT) gauge and Boost gauge be installed with the Six-Gun Diesel Tuner to help monitor performance and exhaust gas temperature of the vehicle (see part numbers next page). To further increase engine life by lower EGT's, Banks also recommends installing a Monster Exhaust® system (see next page).

**Banks iQ System**..... 61146

**Banks Monster® Exhaust System**  
Monster Exhaust (ALL WB)..... 47784  
Dual Monster Exhaust (ALL WB) .. 47785

**Additional Equipment**  
Ram-Air Intake Sys. .... 42172  
Ram-Air® Filter..... 42138  
Ram-Air® Service Kit ..... 90094

**Gauges Assembly**  
Boost and Pyro ..... 64507

**Figure 1** Six-Gun Tuner and supplied wiring harness

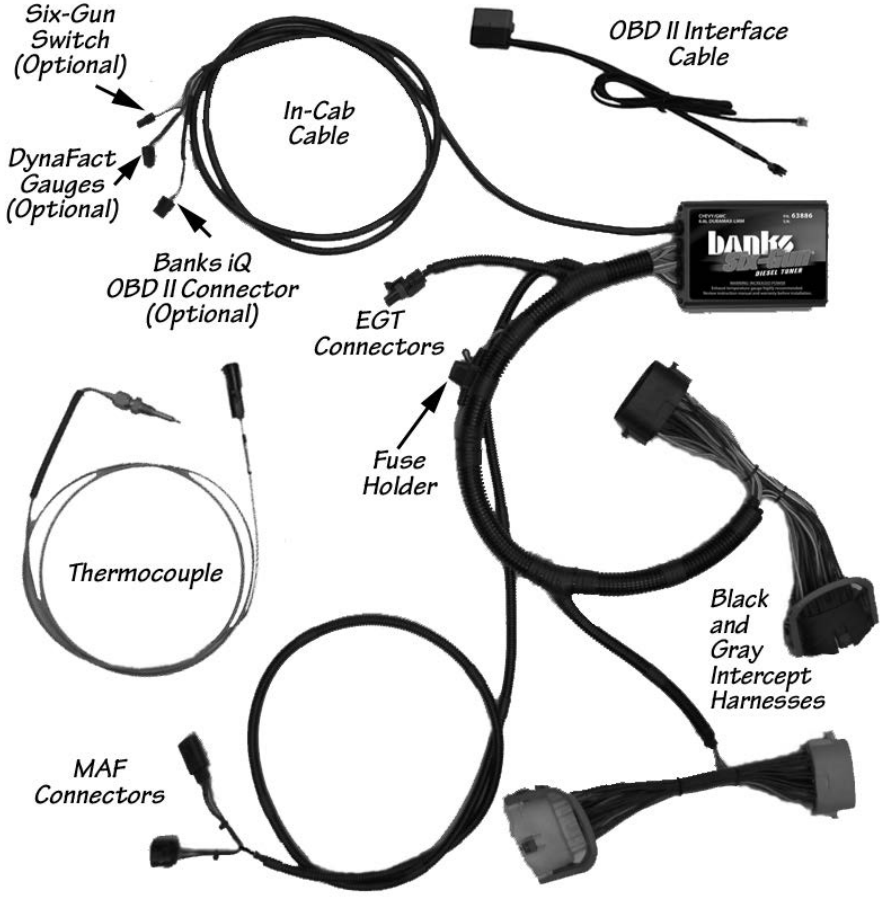

# Section 1

## INSTALLATION OF WIRING HARNESS, CONNECTIONS AND SIX-GUN DIESEL TUNER

**1.** Disconnect the battery ground cables from each of the batteries. Secure the cables so that they do not come in contact with the battery posts during the installation.

**2.** Place the Banks Six-Gun Tuner on top of the fuse box cover. Direct the wire harness towards the rear of the vehicle as shown in **Figure 2**.

*NOTE: Do not attach the Tuner at this time.*

**3.** Locate the black and gray wire harness locking connectors between the brake fluid reservoir and the air conditioning compressor. Slide the green locking tabs back and lift the blue connector locks to disconnect the connector pairs. See **Figure 3**.

*NOTE: A small screwdriver may help in lifting the blue connector locks. Take care not to break the plastic on the connectors.*

*It may be necessary to open the wire harness retainer clip(s) with a screwdriver for added slack when joining the connectors together.*

**4.** Insert the male gray connector on

the Six-Gun harness into the female gray connector on the factory harness. Insert the female gray connector on the Six-Gun harness onto the male gray connector of the factory harness. Repeat this process with the black connectors. See **Figure 3**.

**5.** Go to the air box and remove the stock mass air flow (MAF) connector located on the elbow of the air box cover and set aside.

**6.** Locate the MAF connector from the Six-Gun Tuner harness and route as shown in **Figure 4**. Follow the factory harness located on top of the engine that runs in front of the intake manifold and behind the alternator.

**7.** Connect the Six-Gun Tuner's (female) MAF connector to the factory (male) MAF sensor and connect the factory (female) MAF connector to the Six-Gun's (male) MAF connector.

**8.** Locate the rubber grommet on the driver's side of the vehicle firewall. The grommet is about 3" in diameter. Make a 1" x 1" cross-shaped (X) incision in the grommet. Be careful so you do not cut the factory harness.

**Figure 2**



**Figure 3**

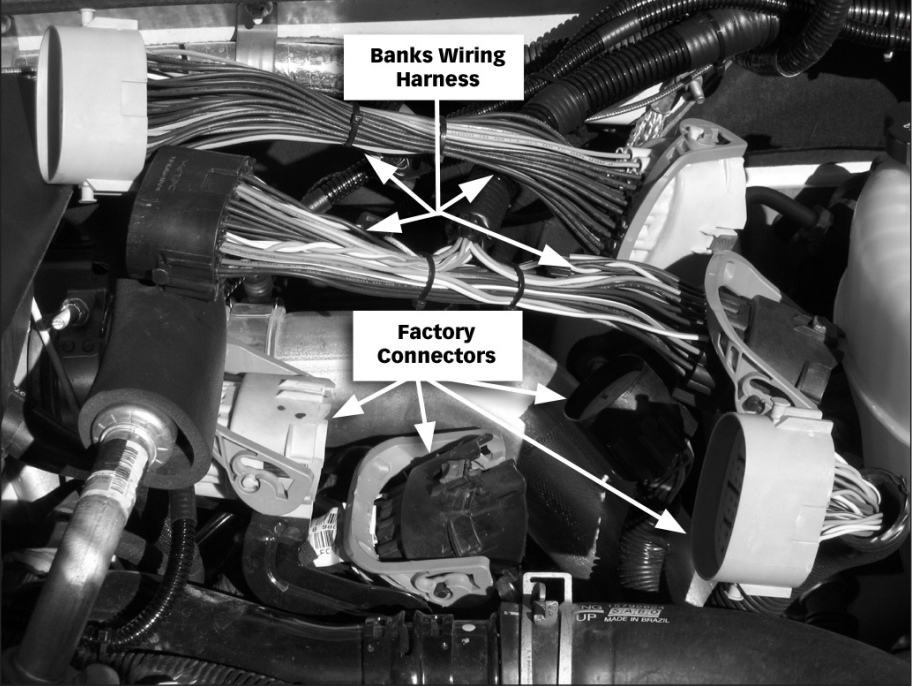

**Figure 4**

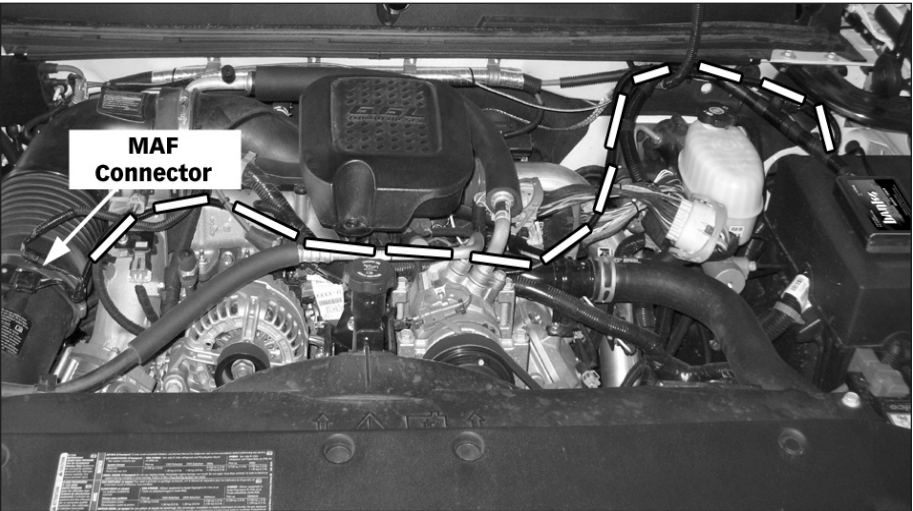



**9.** From inside the cab locate the grommet on the firewall and make another 1" x 1" cross-shaped (X) incision on the grommet, opposite the spot that was cut from the outside. Now, feed the In-Cab cable through the incision made in the firewall grommet and into the cab (**Figure 5**).

*NOTE: Some thick putty may be used to provide additional sealing around the In-Cab cable and the grommet.*

**10.** Position the Tuner on the fuse box cover for an idea of where to clean. The Tuner must be mounted as close to the inside (engine side) edge as possible to avoid a hood clearance issue. Check the hood clearance before attaching the Tuner to the fuse box. Clean the top of the fuse box cover located on the drivers' side of the engine compartment. Make sure the outside of the fuse box is free of oil, grease and dirt.

*NOTE: Clean the fuse box cover with a non-oil based solvent such as Acetone, Mineral Spirits, Denatured Alcohol or Lacquer Thinner. Read and follow the manufacture's operation instruction for non-oil based solvent cleaner.*

**WARNING: Make sure to place the Tuner as shown in Figure 2 to avoid a clearance issue when closing the hood. Mount the Six-Gun Tuner as close to the inside (engine side) edge of the fuse cover as possible. Verify you have hood clearance before mounting the Tuner.**

**11.** Peel the protective backing from the hook and loop interlocking fasteners attached to the Six-Gun Diesel Tuner. Position the side edge of the Six-Gun Diesel Tuner to the edge closest to the engine of the fuse cover, then press the adhesive onto the outside of the fuse box cover. Apply light pressure to the Six-Gun Diesel Tuner by hand for 60-seconds to create a strong bond between the fuse box and hook & loop interlocking fasteners. Using the supplied cable ties, secure the wire harness away from any heat sources or moving components.

**CAUTION: When securing the wires, do not bend them any tighter than a 2.5" diameter bend as this can cause undue stress on the wires and may cause failure.**

-END, SECTION 1-

**Figure 5**

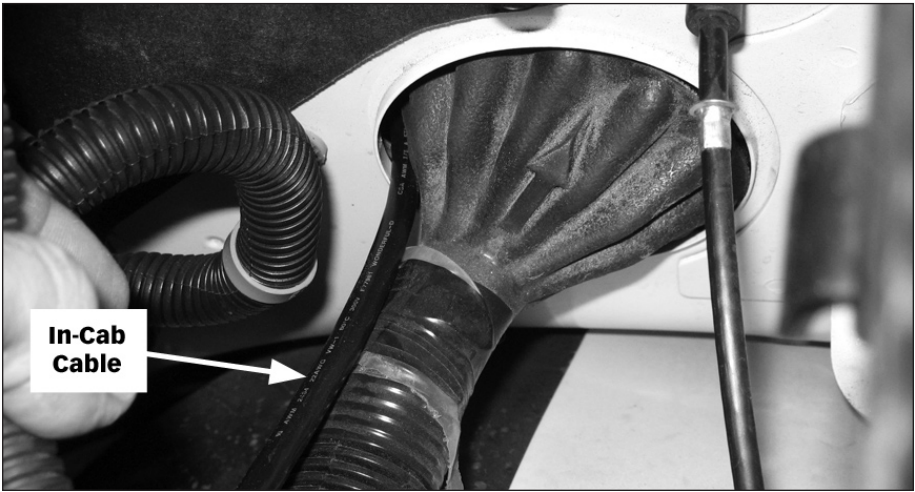

# Section 2

## MOUNTING AND CONNECTING THE BANKS IQ

If not installing the optional Banks iQ, skip to Section 3.

**WARNING:** Below 32° F (0°C) or above 140° F (60°C), the Banks iQ may be susceptible to damage as a result of extended direct exposure to sunlight, heat, or extreme cold. It is highly recommended that the Banks iQ be removed from its mounting location if the vehicle will be subjected to these conditions for an extended period of time. Gale Banks Engineering is not responsible for damage to Banks iQ resulting from exposure conditions.

**CAUTION:** Do not use force when working on plastic parts. Permanent damage to the part might result.

**1.** Locate the Window Mount Assembly in your kit.

**2.** Assemble the Banks iQ docking station to the Universal mount by inserting and sliding the Universal mount tab into the docking station groove. Hand tighten the nut behind the docking station to hold the docking station in place.

**3.** Attach the window mount to your Banks iQ. See **Figure 6**. Align and place the two (2) lower tabs on the window mount to the corresponding slots on the bottom of Banks iQ first then snap the top of Banks iQ into place.

*NOTE:* There may be a snug fit when installing the Banks iQ into the window mount. Take care not to force this process.

**Figure 6** Attaching Banks iQ to window mount

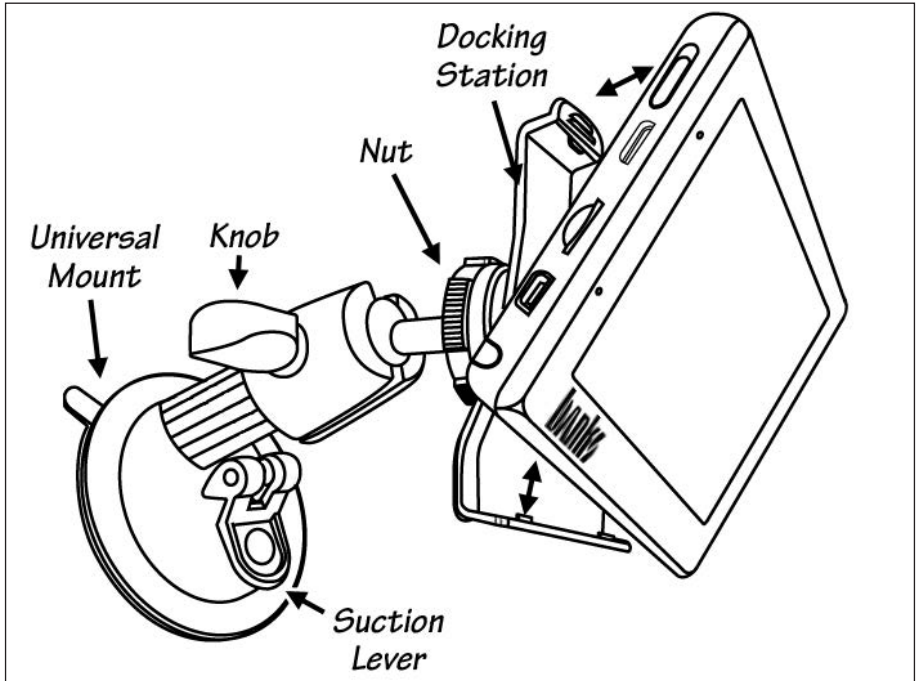

**Figure 7** Chevy LMM Shown



**4.** Find a suitable place on the windshield for ease of access and viewing of Banks iQ. Use location shown in **Figure 7** as a reference for mounting Banks iQ in your vehicle. Loosen the knob and move the swivel suction plate to achieve desired viewing angle of the Banks iQ screen. Do a test fit and note the angle necessary to achieve the correct viewing angle.

**5.** Make sure the suction cup and the mounting area on the windshield are clean and dry. With the suction lever in the up position, ensure the suction cup is flat against the windshield, and then push the suction lever down to secure in place.

**6.** Next, remove and set the fuse access panel aside. See **Figure 7**.

**7.** Find the Banks OBD II Interface Cable in your kit. Connect the Banks Interface Cable to the vehicle's OBD II connector. Use a cable tie as shown in **Figure 8** to secure the Banks

Interface Cable to the vehicle's OBD II connector.

**8.** Next, connect the 6-terminal connector on the Banks OBD II Interface Cable to the 6-pin connector on the Six-Gun Tuner harness.

**9.** Locate the RJ12 Cable (similar to telephone connector) on your Banks OBDII interface cable. See **Figure 9**.

**10.** Locate Banks iQ Bridge Module and connect the RJ12 connector into the Bridge Module. See **Figure 10**.

**11.** Route the Banks iQ USB interface cable from the Banks iQ Bridge Module under the dash and out through the fuse access panel opening. The cable can be slid under the door frame's seal and run up to the top of the dash. Pull enough cable to reach the Banks iQ and connect it to the left receptacle on the iQ. See **Figure 8**. Snap the fuse access panel back in place making sure not to pinch the wire.

**Figure 8**

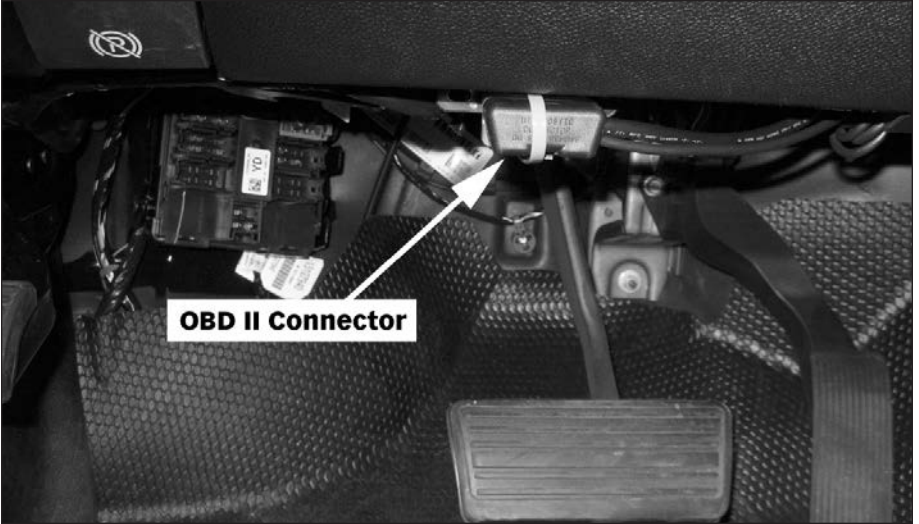

**Figure 9 Banks iQ System**

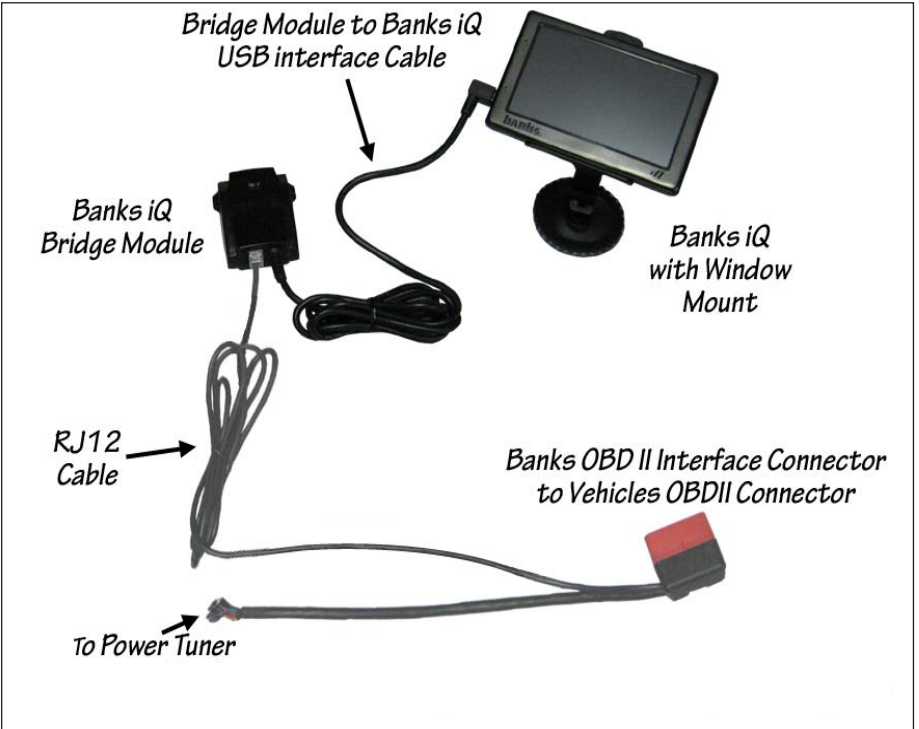

**Figure 10** Banks Bridge Module



**WARNING: THE CHARGING CABLE CONNECTED TO THE BANKS iQ IS DESIGNED TO SUPPLY A CONSTANT LOW-VOLTAGE POWER SOURCE (+5VDC) TO THE BANKS iQ AND IS "LIVE" AS LONG AS THE SYSTEM'S OBD II INTERFACE CABLE OR BANKS WIRING HARNESS IS COMPLETELY INSTALLED AND THE USB CABLE CONNECTOR IS PLUGGED INTO BANKS iQ. ALTHOUGH THIS CHARGING CABLE IS SHORT AND ITS CIRCUITRY IS FUSE-PROTECTED, THE USER IS EXPECTED TO TAKE APPROPRIATE MEASURES TO PREVENT SMALL CHILDREN AND/OR PETS FROM CONTACT WITH ANY PART OF THIS SYSTEM.**

**12.** Secure Banks iQ Bridge Module under the dash to any dash frame support using the supplied cable ties. Use the cable tie support loops on the side of the Bridge Module to securely fasten it under the dash.

**13.** Route all wiring away from any pedals or other moving components. Using the cable ties supplied, secure the wiring under the dash.

**14.** Re-connect the negative (ground) cable(s).

-END SECTION 2-

# Section 3

## INSTALLATION OF THE (OPTIONAL) SIX-GUN SELECTOR SWITCH

Not needed if the optional Banks iQ is installed.

**CAUTION: Do not use force when working on plastic parts. Permanent damage to the part may result.**

*NOTE: Before drilling, confirm that there is adequate room for the Switch and wires behind the dash. Make sure wires or obstructions are cleared from the drilling area.*

*From where the Six-Gun Switch will be located, make sure there is enough wire on the In-Cab Cable to reach the Switch.*

**1.** The Six-Gun Switch can be installed on the driver's side of the instrument panel (IP) to the left side of the steering column. There are two dash types: Dash 1 (**Figures 11, 12**) and Dash 2 (**Figures 13, 14**).

*NOTE: These are just suggested locations. It is possible to locate the Six-Gun Switch where it is more comfortable. Please confirm space behind dash before drilling.*

**2.** To install on the driver's side IP (Dash 1, **Figure 11**):

Pull the IP trim out by pulling the top edge above the vent as shown in **Figure 15**. Disconnect any switch wires.

**3.** Cut out the supplied template, **Figure 25**, and align the dashed lines to the edge of the IP where you would like to mount the Switch. Tape the template in place. Continue to Step 7.

**4.** To install the Switch to the left side of the steering column (Dash 2 **Figure 14**):

**Figure 11**



**Figure 12**

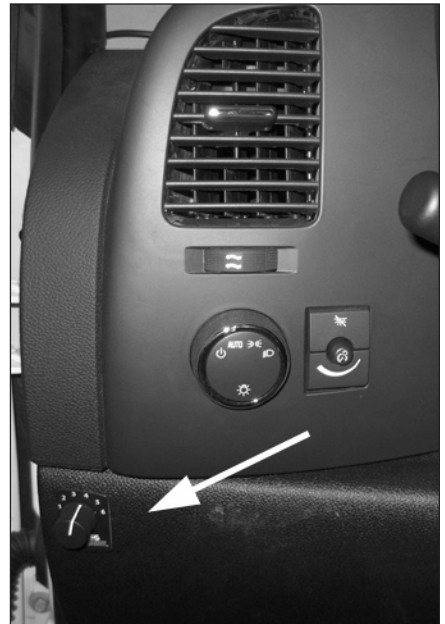

**Figure 13**



**Figure 14**

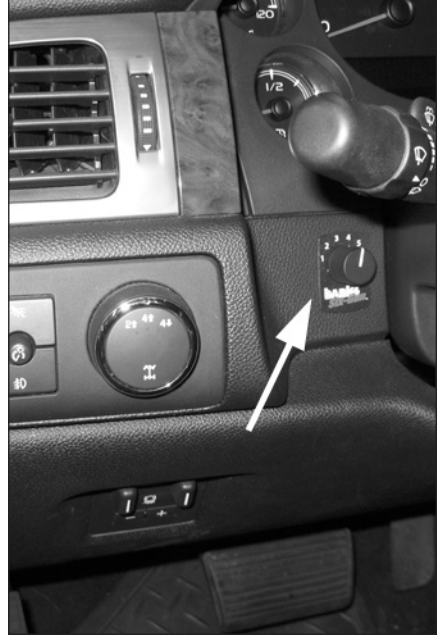

**Figure 15**



Remove the fuse access panel shown in **Figure 7**. Remove the lower knee bolster panel by removing the 2 Phillips screws on the lower edge of the panel. Using a 10mm socket and ratchet, unbolt the brake release lever. Pull the panel out by grasping it on either side of the steering column and pull out as shown in **Figure 16**. Disconnect any switch wires.

**5.** Cut out the supplied template, **Figure 25**, and align the template to the right edge of the IP to the left of the steering column. Tape the template in place. A 90° drill will be needed to drill the hole. Continue to Step 7.

**6.** To install Switch as shown in **Figures 12 & 13**:

Follow Step 4 to remove the IP for both Dash styles. Cut out the supplied template, **Figure 26**, and align the template onto the rear of the knee

bolster, squarely seating it into the panel corner as shown in **Figure 17**.

**7.** Using a 3/8" Uni-bit step drill bit or a 3/8" drill bit, center the bit onto the 3/8" drill location on the template and slowly drill through the IP. Using a 1/8" drill bit, center and drill through the 1/8" location on the template. Remove and discard the template and any plastic shavings.

**8.** On the front side of where the Switch will be mounted, clean the area with some alcohol and allow it to dry. Remove the backing from the Six-Gun Label and align it over the previously drilled hole.

**9.** Remove the nut and internal tooth washer from the Six-Gun Switch. Rotate the shaft counter clockwise until the shaft stops. Verify the locating washer tab is inserted into the #6 position on the Switch (**Figure 18**).

**Figure 16**

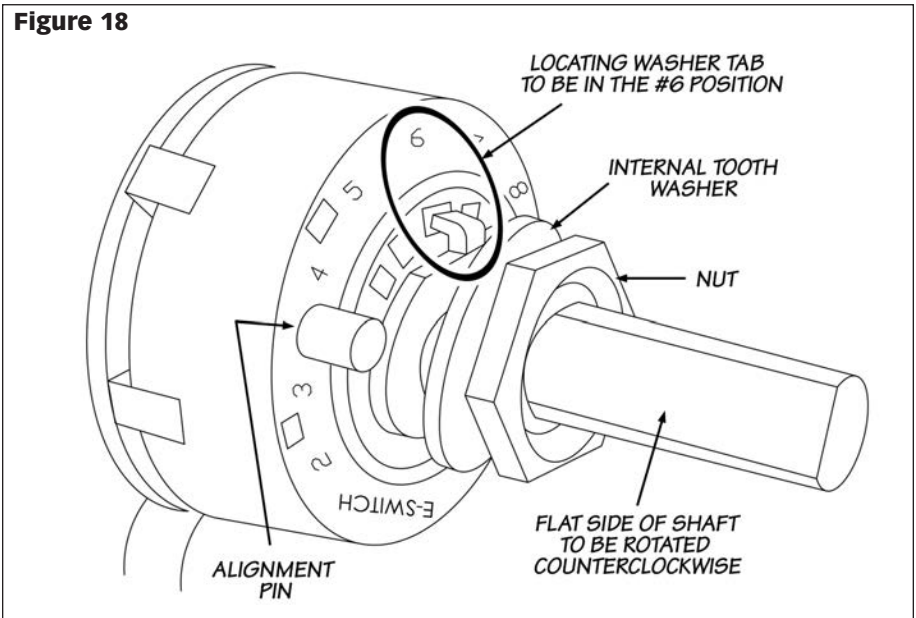



**Figure 17- Rear template used**



**Figure 18**



*NOTE: If the washer is in any position other than the #6, your Six-Gun Diesel Tuner will not select power levels properly.*

**10.** After confirming the locating washer is in the #6 location, install the Switch through the  $\frac{3}{8}$ " hole. The alignment pin should rest in the  $\frac{1}{8}$ " hole. With the Switch fully rotated counter clockwise the shaft's flat side should be facing the steering column. Secure the Switch with the internal tooth washer and nut. Snug the washer; be careful not to over torque the nut and damage the plastic threads.

**11.** Install the knob onto the shaft facing the #1 Level on the Six-Gun label. On the knob, snug the two (2)

set screws with the supplied 0.050" hex key wrench.

**12.** Route the Six-Gun Switch Cable down to the Six-Gun Diesel Tuner's In-Cab Cable underneath the dashboard, and reinstall any panel(s) that were removed.

*NOTE: Take care to keep any cables away from the pedals or where they could become tangled.*

**13.** Connect the Six-Gun Switch's 2-terminal receptacle to the 2-terminal plug on the Six-Gun Diesel Tuner's In-Cab Cable.

**14.** Re-connect the negative (ground) cable(s).

-END, SECTION 3-

**Figure 19**

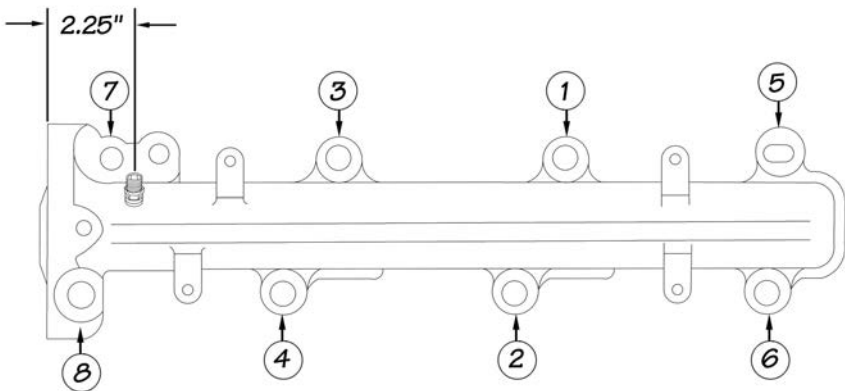

# Section 4

## OPTIONAL THERMOCOUPLE INSTALLATION (REQUIRED FOR OPTIONAL BANKS IQ)

- 1.** The thermocouple monitors the temperature of the exhaust gases entering the turbocharger at the turbine housing. Installation requires that the exhaust manifold be drilled near the manifold outlet. It is recommended that the manifold be removed from the engine to thoroughly clean out all metal chips from drilling. If the manifold is not removed from the vehicle, all chips must be removed from the manifold. This may be accomplished by using a magnet to extract the chips after drilling. The tap should be greased before use and the chips again removed with a magnet. All metal shavings must be cleaned from the manifold to avoid turbine damage.
- 2.** To access the exhaust manifold, remove front passenger wheel well by removal of plastic retainers.
- 3.** On the passenger side, remove the hardware retaining the turbine inlet exhaust pipe to the exhaust manifold. Then, remove the exhaust manifold from vehicle. Pay special attention to the orientation of the manifold outlet gasket. Retain the hardware and gaskets for re-assembly.
- 4.** Center punch and drill through the passenger side exhaust manifold into the rear passage at the location shown in **Figure 19**. Use an "R" drill bit, keeping the drill perpendicular to the manifold surface.
- 5.** Tap the drilled hole with a 1/8" NPT pipe tap. Check the thread depth as you tap by periodically removing the tap and screwing the thermocouple

insert into the tapped hole. The thermocouple insert should be tight and snug when half it's threads are screwed into the manifold.

- 6.** Install the thermocouple insert into the manifold using anti-seize compound on the threads. Install the probe in the thermocouple insert.
- 7.** Make sure to remove all shavings from inside the exhaust manifold. Reinstall the exhaust manifold. Torque to 28 lb-ft (38 Nm) in the sequence shown in **Figure 19**.
- 8.** Route the thermocouple connector along the factory harness to the driver's side and connect it to the Six-Gun's EGT connector. Use the supplied cable ties to secure the harness.

*NOTE: Once the Six-Gun Diesel Tuner is powered up at key-on, it will 'learn' that a thermocouple is installed and automatically enable the EGT limiting function.*

If the thermocouple is removed after being installed and run on the vehicle, the Six-Gun Diesel Tuner will assume that the sensor or connection has gone bad and will cease adding power while triggering the [2,3] diagnostic code (see Troubleshooting Section). To ensure that the Six-Gun Diesel Tuner operates properly after removing a previously installed thermocouple, see the 'Clearing Learned Information' **Section 9**. EGT limiting will not be operational and excessive EGTs may develop at higher power levels.

-END, SECTION 4-

# Section 5

## AUTOMATIC TRANSMISSION LEARNING

*NOTE: Please refer to the Banks IQ Software & Installation Kit Owner's Manual for software installation and operation instruction before beginning Section 6, Automatic Transmission Learning.*

The 6.6L Chevy Duramax Trucks equipped with the Allison 1000 6-speed automatic overdrive transmission use an adaptive shift control logic. This will require the transmission to adapt to the additional power created by the Banks Power products before it will shift properly. Failure to follow the sequence can result in damage to the transmission.

Perform the following sequence at a location where it is safe to accelerate without exceeding the posted speed limit.

- 1.** Set Six-Gun Tuner to Level 1 power setting, start the truck and allow the engine to reach normal operating temperature.
- 2.** Adjust Six-Gun to Level 2, power setting.
- 3.** Drive vehicle for 5 to 10 miles ensuring a complete shift cycle through each gear. (The transmission shift adaptation learning process requires

15 to 30 complete shift cycles to learn new shift program.)

- 4.** Increase power level by one and repeat Step 3 until the desired power level is achieved.

**WARNING: Take particular care not to do wide open runs in 5th gear when in Automatic transmission Learning Mode.**

The Allison 1000 6-speed automatic transmission will continually adapt to the power output of the engine to optimize shift quality. The transmission will quickly adapt to the power setting if the driving cycle includes regular gear changes at high loads. The transmission learning procedure will need to be repeated when switching back to the higher power settings once the transmission adapts to the lower power settings. It will be apparent when the transmission adapts to the lower settings by monitoring the feel of the gearshift. Gear changes will be noticeably harder when initially switching from a higher to lower power setting. This will soften as the transmission adapts to the new setting.

-END, SECTION 5-

# Section 6

## CHECKING ENGINE PERFORMANCE

The Six-Gun Diesel Tuner requires the engine coolant temperature (ECT) to be above 110° before it will add fuel. If the optional Banks IQ or DynaFact® gauges are installed, observe the operation of the boost and pyrometer (EGT) gauge values while driving under varying conditions. Turbocharger boost pressure will increase as a function of load and engine RPM, thus the engine will produce little boost while cruising at light throttle, with maximum boost while climbing hills, heavily loaded, and/or during acceleration. Note the boost level seen during hard acceleration with a given load. If performance seems to have deteriorated sometime in the future, the maximum boost figures may be compared to see if boost has dropped off. Lower boost may be caused by turbo ducting leaks, a malfunctioning wastegate or fuel injection pump, or dirty air filter. Typical maximum boost pressure settings will vary considerably between automatic transmissions, year model of vehicle, and altitude.

*NOTE: Before key-off, check Tuner for error codes. Use your Banks IQ or EGT gauge to monitor exhaust gas temperature (EGT) in the engine. At*

*idle, exhaust gas temperature will be very low, perhaps only 300°F. As the engine is accelerated for higher speeds with greater loads, the EGT will rise. The highest EGT will be seen under maximum load at full throttle, such as climbing a steep grade with a heavily laden vehicle. To avoid heat damage to various engine components it is recommended that the exhaust gases cool below 400°F before the engine is shut down. Your Six-Gun Diesel Tuner is calibrated to maintain EGTs depending on power level.*

Level	EGT
1-5	1350°F
6	1400°F

*You may experience brief excursions slightly above the temperatures listed under acceleration. This is normal and the EGT should return to or below the proper temperature within a few seconds. If you find that EGT remains high for any length of time, check for boost leaks or a dirty air filter.*

-END, SECTION 6-

## Section 7

### TROUBLESHOOTING

#### Six-Gun Troubleshooting Using The Banks iQ

Check the Banks iQ's Status indicator for the "OK" icon on the upper left corner of the iQ screen. Any Tuner fault will be indicated by the "Banks Engine" icon (see **Figure 20**) and its cause can be investigated by running a 'Power Diagnostic' from the Diagnostic menu.

**Figure 20**



*Banks Engine  
Icon*

1. In the Environment select menu press on the 'Diagnostics' button. See **Figure 21**.
2. In the Diagnostics menu press on the 'Tuner Diagnostics' button to run a tuner diagnostics. See **Figure 22**.
3. The 'Self Diagnostic' screen displays a log of diagnostic events related to the Tuner. The 'Logged

Events' list takes a moment to update each time this screen is opened. Once the list is updated, the most current event will appear at the bottom of the list. Each event has an associated timestamp and description, which will be displayed below the list when that event is highlighted. Each key cycle of the vehicle produces a minimum of two logged events. See **Figure 23**. **Table 1** lists the common diagnostic codes and the suggested Course of Action for each.

4. Use the arrow buttons to scroll through the recorded events.
5. Touch the iQ icon on the lower left of the screen to return to the environment screen or the return icon to return to the Diagnostics menu.
6. A pop-up "Log-File" screen will appear asking you if you want to erase the contents of the log. Press 'No' to keep the contents on Log-file or 'Yes', to erase the Log-files.

**Figure 21**



Figure 22

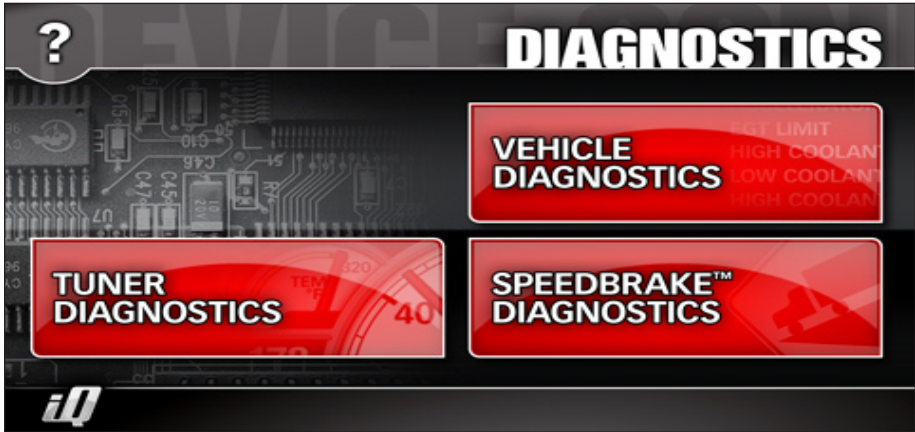

Figure 23



### Six-Gun Troubleshooting using the Tuner's LEDs.

*(With or without a Banks iQ Installed)*

If you feel that your Six-Gun Diesel Tuner is not functioning properly, some diagnostics can be performed. Your Six-Gun Diesel Tuner is equipped with diagnostic features that will detect and display certain errors.

Remove the Six-Gun Diesel Tuner from its mounting location while keeping all connectors plugged in, and position

it in such a way that you can view the end of the Six-Gun housing that contains the LEDs from the driver's seat. Turn the vehicle key to the ON position. Observe the two LEDs mounted on the end of the Six-Gun Diesel Tuner:

- A steady GREEN LED will illuminate if all wire connections are correct, the engine is running, and the engine coolant temperature is within its normal operating range.

**Table 1: Six-Gun Troubleshooting**

<b>Code</b>	<b>Banks iQ Error Message</b>	<b>Corrective Action</b>
<b>1,1</b>	Fuel Rail Pressure (FRP) Input Voltage Out of Range.	Turn ignition OFF for 60 seconds and check the black and gray connectors. Turn ignition back ON and re-check for presence of code.
<b>1,2</b>	Manifold Absolute Pressure (MAP) Input Voltage Out of Range.	Turn ignition OFF for 60 seconds and check the gray and black connectors. Turn ignition back ON and re-check for presence of code.
<b>1,3</b>	Six-Gun Switch Input Value Out of Range.	Turn ignition OFF for 60 seconds and make sure either Banks iQ or Six-Gun switch is connected to the Six-Gun tuner. If the Six-Gun switch is connected (no Banks iQ), check the 2-terminal connection on Tuner's In-Cab cable. If Banks iQ is connected (no Banks Six-Gun switch), check the 4-terminal connection on the Tuner's In-Cab cable. Turn ignition back ON and re-check for presence of code.
<b>1,4</b>	Mass Air Flow (MAF) Input Voltage Out of Range.	Turn ignition OFF for 60 seconds and check the 5-Terminal MAF connector. Turn ignition back ON and re-check for presence of code.
<b>2,1</b>	Fuel Rail Pressure (FRP) Output Voltage Out of Range.	The FRP sensor may be bad. Turn ignition OFF for 60 seconds and check the gray and black connectors. Turn ignition back ON and re-check for presence of code.
<b>2,2</b>	Manifold Absolute Pressure (MAP) Output Voltage Out of Range.	The MAP sensor may be bad. Turn ignition OFF for 60 seconds and check the black and gray connectors. Turn ignition back ON and re-check for presence of code.
<b>2,3</b>	Exhaust Gas Temperature (EGT) Sensor Circuit Fault.	Turn ignition OFF for 60 seconds and check the thermocouple connectors. Turn ignition back ON and re-check for presence of code.
<b>2,4</b>	Mass Air Flow (MAF) Output Voltage Out of Range.	The MAF sensor may be bad. Turn ignition OFF and check the 5-Terminal MAF connector. Turn ignition back ON and re-check for presence of code.
<b>3,1</b>	Engine Position Sensor Fault.	Turn ignition OFF for 60 seconds and check the gray and black connectors. Turn ignition back ON and re-check for presence of code.
<b>3,2</b>	Internal Module Malfunction or Intermittent Power.	Turn ignition OFF for 60 seconds and check the black and gray connectors. Check the Tuner's fuse. Turn ignition back ON and re-check for presence of code.
<b>3,3</b>	EGR Valve Position Input Voltage Out of Range.	Turn ignition OFF and check the black and gray connectors. Turn ignition back ON and re-check for presence of code.
<b>3,4</b>	OBDII CAN communication error	Turn ignition OFF for 60 seconds and check the gray and black connectors. Turn ignition back ON and re-check for presence of code.
<b>4,1</b>	Injection Control Signal Fault.	Turn ignition OFF for 60 seconds and check the gray and black connectors. Turn ignition back ON and re-check for presence of code.
<b>4,2</b>	Transmission Slippage Detected.	Transmission is slipping excessively. Code will automatically clear once transmission stops slipping (repaired). If code is thrown, torque convertor needs to lock and unlock 5x before code is cleared from transmission.
<b>4,3 or 4,4</b>	Internal Module Malfunction.	Turn ignition OFF. Turn ignition back ON after 60 seconds and re-check for presence of code. If error is still present, turn ignition OFF and check all connectors. Check the Tuner's fuse. Turn ignition back ON and re-check for presence of code.

If any code is displayed or is persistent, pull the connectors apart and check the terminals. A terminal may not have been seated correctly during manufacturing and it may have moved when connected. If it appears that a terminal has moved, gently pull on it with small needle nose pliers to lock it in place.



- The GREEN LED will flash if all wire connections are correct, the engine is running, but the engine coolant temperature is not within its normal operating range. The GREEN LED will stop flashing once the engine coolant temperature is within its normal operating range (not to be confused with Speed-Loader flash on power-up).

- No LEDs will illuminate if the fuse on the Six-Gun wiring harness is blown or the wiring harness is not properly connected. If the fuse and all connections are okay, contact Banks Technical Service.

- The RED LED will flash in a certain sequence if a connection is incorrect or if there is a problem with the system – this sequence will identify one or more diagnostic codes. A Six-Gun Diesel Tuner's diagnostic code is comprised of 2 digits. Each code is expressed in a sequence of 2 sets of the flashing red LED separated by a brief flashing of the green LED in between. Each set of a number of red LED flashes represents a digit. A longer flashing of the green LED separates the sequences. The LEDs will continue

to flash to display all the errors, and then repeat. **Table 1** lists common diagnostic codes. For example, if a faulty thermocouple is detected (code "2,3") by the Six-Gun Diesel Tuner, the following red and green LED flashing sequence is observed when the key is on:

- (1) Two times flashing RED LED
- (2) One time quick flashing GREEN LED
- (3) Three times flashing RED LED
- (4) One time longer flashing GREEN LED

The above flashing sequence will repeat continuously. When the problem is corrected, the diagnostic code will be eliminated and replaced by a steady green light. If the problem persists, contact Banks Technical Service.

*NOTE: If multiple codes are set, they will be displayed in a series separated by the longer flashing green LED. When reading codes, make sure to watch the entire series until you see the first code repeat.*

-END, SECTION 7-

# Section 8

## CLEARING LEARNED INFORMATION

If the Six-Gun Diesel Tuner has been moved to a different vehicle, or you are instructed to do so by Banks Technical Staff, it is possible to reset all of the parameters that the Six-Gun has 'learned' - presence of an EGT thermocouple or Speed-Loader, etc.

**CAUTION: The following procedures can only be carried out with the engine OFF!**

1. Turn the vehicle key to ON but DO NOT start the engine.
2. Fully depress the throttle pedal

and then release it completely. Repeat 5 times. The Tuner's GREEN LED will flash when this is completed successfully.

3. Turn the key OFF. Wait 60 seconds and make sure the GREEN LED goes off and stays off. Turn the key back to the ON position but DO NOT start the engine.
4. Fully depress the throttle pedal and then release it completely. Repeat 5 times.

-END, SECTION 8-

# Section 9

## REMOVAL OF THE SIX-GUN DIESEL TUNER

If the Six-Gun Diesel Tuner should ever need to be removed from the vehicle, perform the following:

1. Disconnect the negative (ground) cable from the battery (or batteries, if there are two) before beginning work.
2. Disconnect the Six-Gun's gray connector from the factory harness.
3. Re-connect the vehicle's gray connector back into the factory harness.
4. Disconnect the Six-Gun's black connector from the factory harness.
5. Re-connect the vehicle's black connector back into the factory harness.

6. Disconnect the EGT thermocouple connector. The thermocouple may be left in place or removed if a suitable plug is used.

7. Disconnect the 'In-Cab Cable' and gently pull the cable back through the firewall.

8. Remove the Six-Gun Diesel Tuner. Failure to follow the above instructions when removing the Tuner will result in a "Check Engine" light on the dash and a Diagnostic Trouble Code being stored in the factory computer, in addition to the engine not running.

9. Re-connect the negative (ground) cable(s).

-END, SECTION 9-

# Section 10

## PLACEMENT OF THE BANKS POWER DECALS

Figure 24

TYPICAL LEFT FENDER PLACEMENT

**BANKS  
POWER**

DURAMAX DIESEL



TYPICAL RIGHT FENDER PLACEMENT

**BANKS  
POWER**

DURAMAX DIESEL



**Figure 25- Use only when drilling from the front**

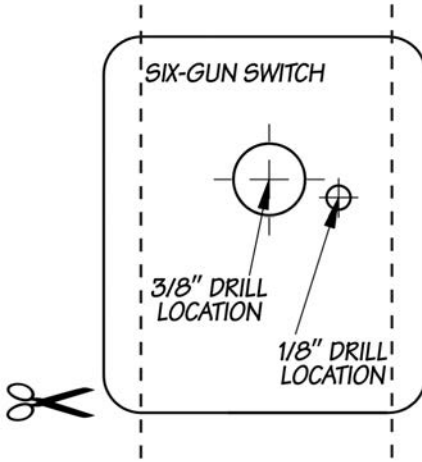

**Figure 26- Use only when drilling from the rear**

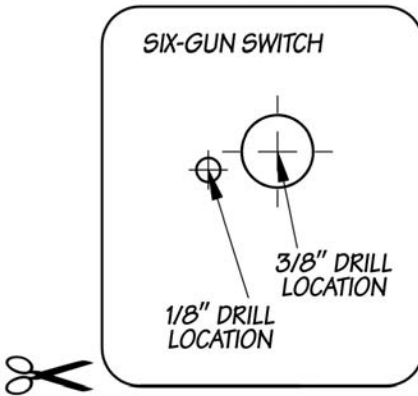

Gale Banks Engineering  
546 Duggan Avenue • Azusa, CA 91702  
(626) 969-9600 • Fax (626) 334-1743

Product Information & Sales: (888) 635-4565  
Customer Support: (888) 839-5600  
Installation Support: (888) 839-2700

**bankspower.com**